

# RS 175

## Digital Wireless Headphone System



Quick Guide  
Kurzanleitung  
Guide rapide  
Instrucciones resumidas  
Guida rápido

Beknopte handleiding  
Guida rapida  
Kort vejledning  
Snabbguide  
Pikaohje



Package includes | Lieferumfang | Contenu | Contenido del paquete | O pacote inclui | De levering omvat | Il pacchetto include | Leveringsomfang | Medföljande delar | Toimitussisältö

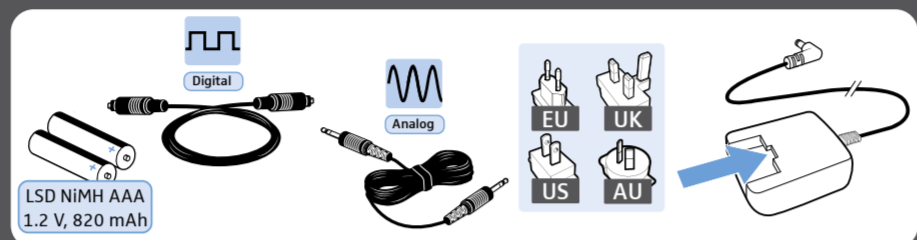
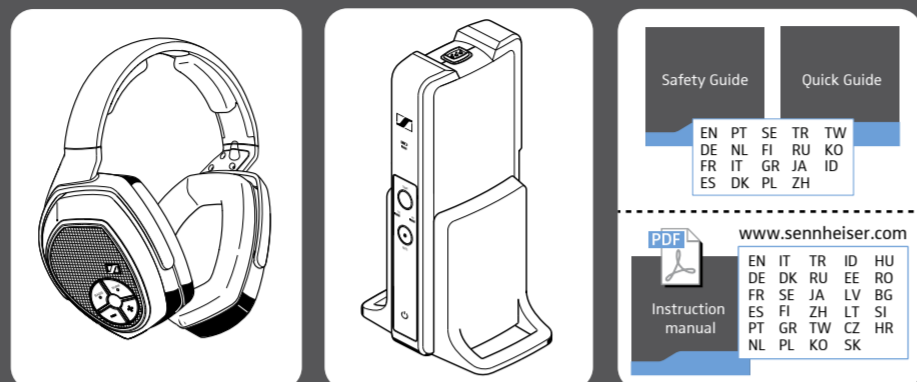

1 Connecting the transmitter to a sound source | Sender an eine Audioquelle anschließen | Raccorder l'émetteur à une source audio | Conectar el transmisor a una fuente de audio | Ligar o emissor a uma fonte áudio | De zender op een geluidsbron aansluiten | Collegamento del trasmettitore a una sorgente audio | Tilslutning af sender til en audiokilde | Anslut sändaren till en ljudkälla | Lähettimen yhdistäminen äänilähteeseen

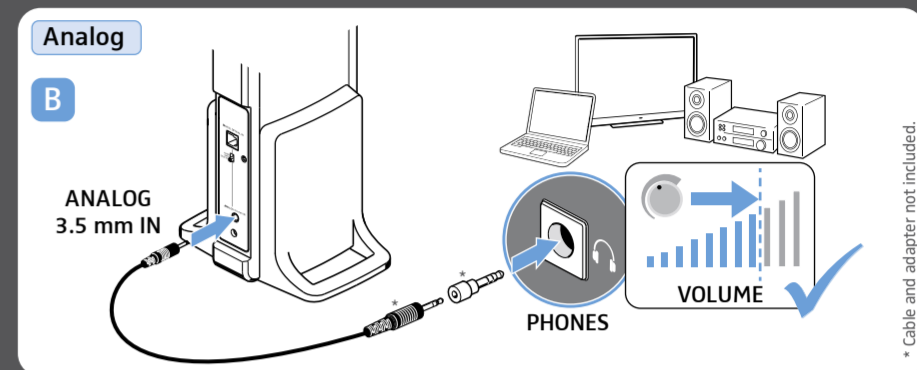
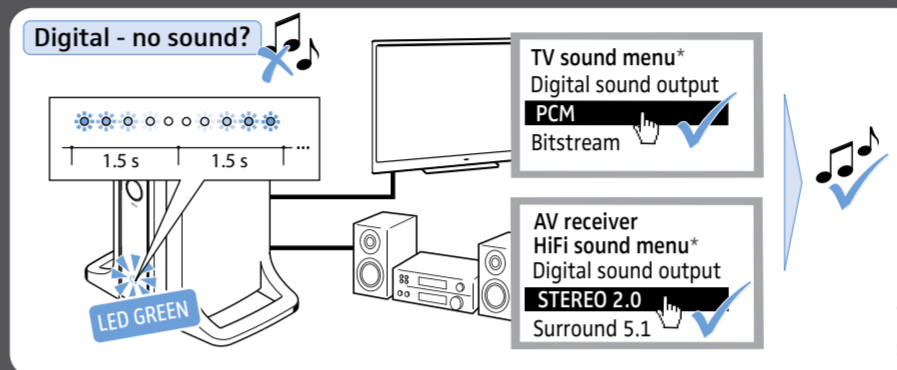
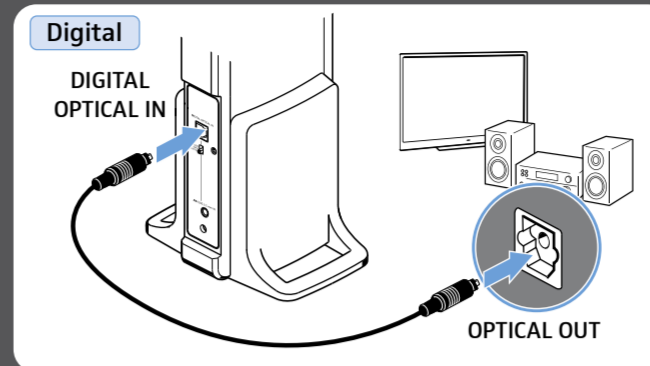
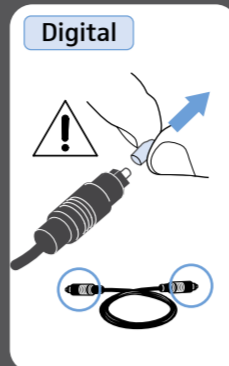

[www.sennheiser.com/how-to-videos](http://www.sennheiser.com/how-to-videos)



2 Connecting the transmitter to an AC wall outlet | Den Sender an das Stromnetz anschließen | Raccorder l'émetteur au secteur | Conectar el transmisor a una toma de corriente AC | Ligar o transmissor a uma tomada CA | Sluit de zender op een wandcontactdoos aan | Collegamento del trasmettitore ad una presa a muro CA | Tilslutning af senderen til strømnettet | Anslut sändaren till elnätet | Lähettimen yhdistäminen sähköverkkoon

3 Inserting or replacing the rechargeable batteries | Akkus einsetzen oder auswechseln | Insérer ou changer les accus | Colocar o sustituir las pilas recargables | Colocar ou substituir as baterias recarregáveis | Plaats of vervang de oplaadbare batterijen | Inserimento o sostituzione delle batterie ricaricabili | Isætning og udskiftning af batterier | Sätt in eller byt batterierna | Akkujen sijoittaminen paikalleen tai vaihtaminen

4 Charging the rechargeable batteries | Akkus laden | Charger les accus | Cargar las baterías | Carregar as pilhas recarregáveis | Accu's opladen | Caricamento delle batterie | Opladning af batterier | Ladda batterier | Akkujen lataus

5 Switching the RS 175 on and selecting the audio input | RS 175 einschalten und Audioeingang auswählen | Allumer le RS 175 et sélectionner l'entrée audio | Encender los RS 175 y seleccionar la entrada de audio | Ligar o RS 175 e selecionar a entrada áudio o | Schakel de RS 175 in en kies de audio-ingang | Accensione dell'RS 175 e selezione dell'ingresso audi | Tilkobling af RS 175 og valg af audioindgang | Slå på RS 175 och välj ljudingång | Järjestelmän RS 175 kytkeminen päälle ja audiotulon valitseminen

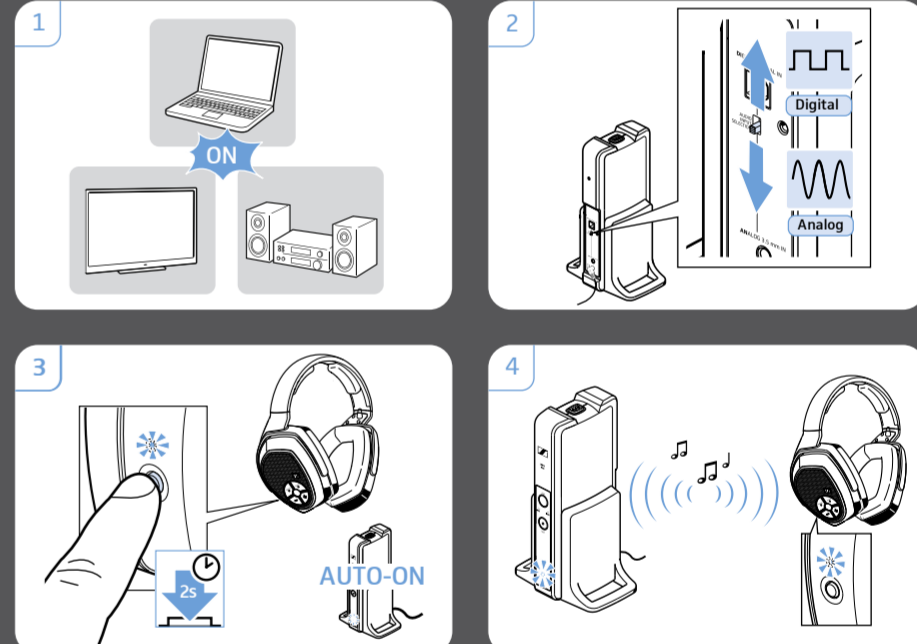
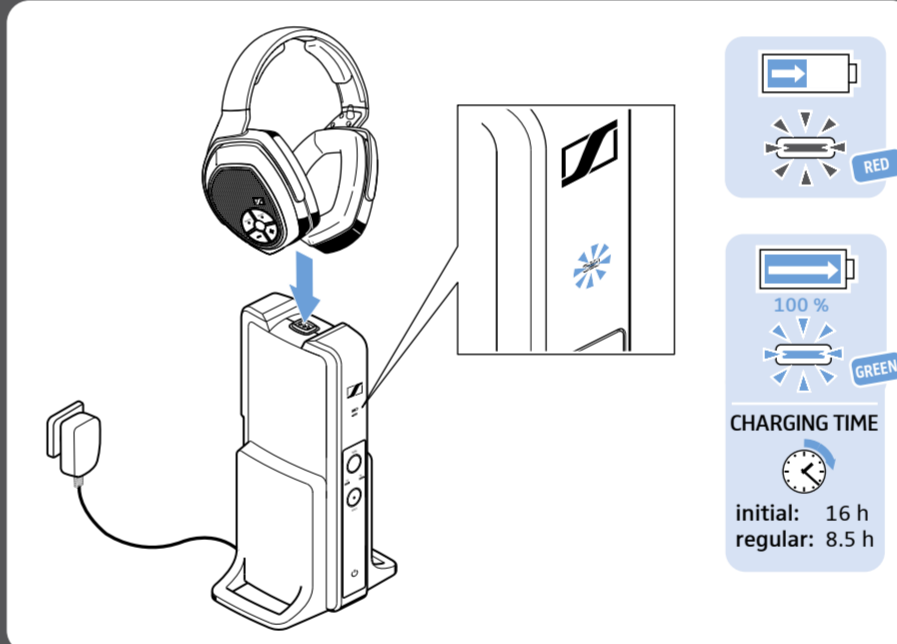
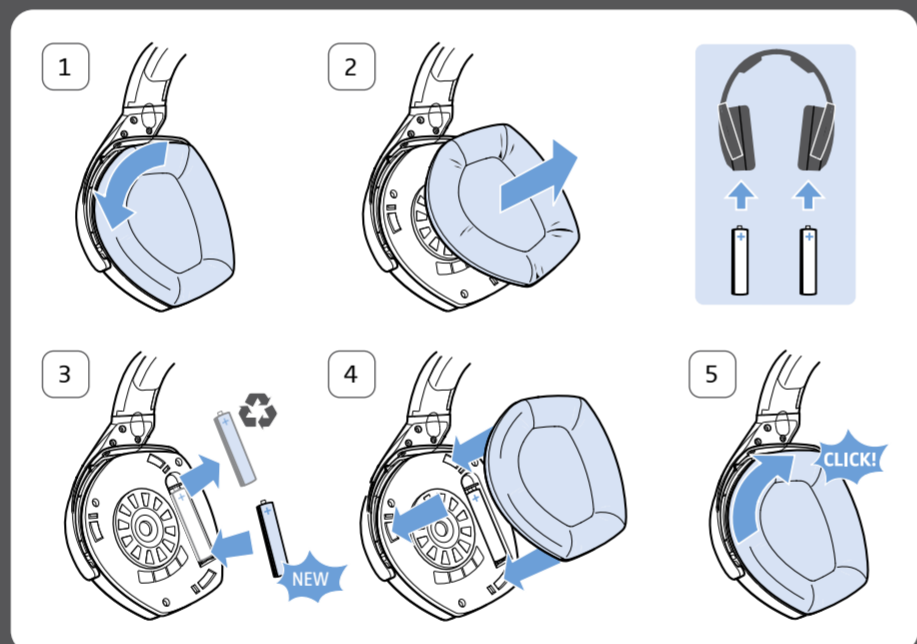
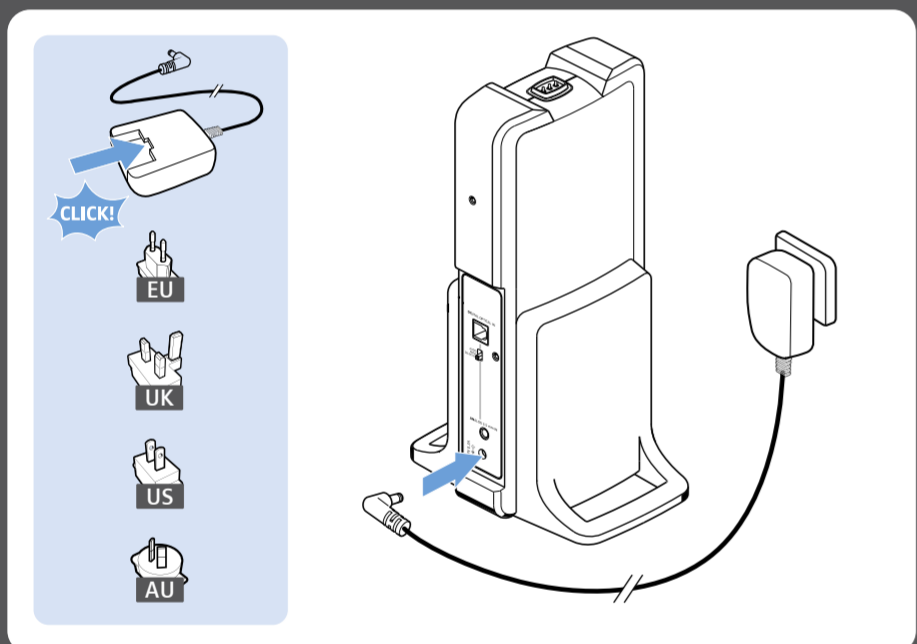

6 Activating/deactivating the dynamic bass boost | Dynamische Bassanhebung ein- und ausschalten | Activer/désactiver l'accentuation dynamique des graves | Activar/desactivar el amplificador de bajos dinámico | Ativar/desativar o reforço dinâmico de graves | Schakel de dynamische bas boost in of uit | Attivazione/disattivazione del bass boost dinamico | Til- og frakobling af dynamisk basforstærkning | Aktivera och avaktivera dynamisk basförstärkning | Dynaamisen bassotoiston tehostustoiminnon kytkeminen päälle ja pois päältä

7 Toggling between different surround sound levels | Zwischen verschiedenen Surround-Sound-Modi umschalten | Basculer entre différents niveaux de son surround | Cambiar entre diferentes niveles de sonido envolvente | Alternar entre diferentes níveis de som surround | Schakel tussen de verschillende surround-geluidsniveaus | Commutazione tra diversi livelli di suono surround | Omstilling mellem forskellige surround-sound-modi | Växla mellan olika surroundljudslägen | Siirtyminen surround-äänitilasta toiseen

8 Adjusting the volume | Lautstärke einstellen | Régler le volume | Ajustar el volumen | Ajustar o volume | Volume instellen | Impostazione del volume | Indstilling af lydstyrke | Ställ in volymen | Äänvoimakkuuden säätäminen

9 Switching the RS 175 off | RS 175 ausschalten | Éteindre le RS 175 | Apagar el RS 175 | Desligar o RS 175 | De RS 175 uitschakelen | Spegnimento di RS 175 | Frakobling af RS 175 | Stäng av RS 175 | Kuulokkeiden RS 175 kytkeminen pois päältä

Detailed instruction manual and additional information | Ausführliche Bedienungsanleitung und weitere Informationen | Notice d'emploi détaillée et plus d'informations | Manual de instrucciones detalladas e información adicional | Manual de instruções detalhadas e informações adicionais | Gedetailleerde gebruiksaanwijzing en aanvullende informatie | Manuale con istruzioni per l'uso dettagliate e informazioni aggiuntive | Udførlig betjeningsvejledning og yderligere informationer | Utførlig bruksanvisning och mer information | Yksityiskohtainen käyttöohje ja lisätietoja

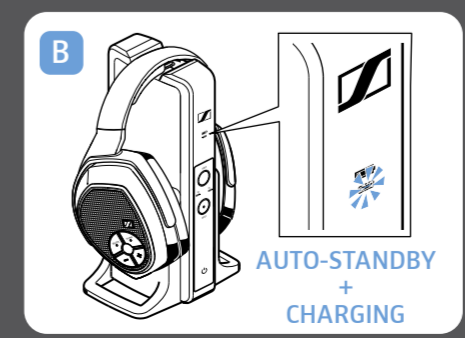
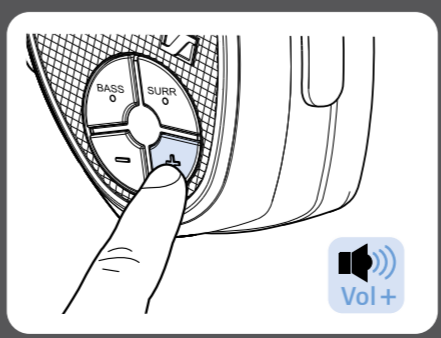
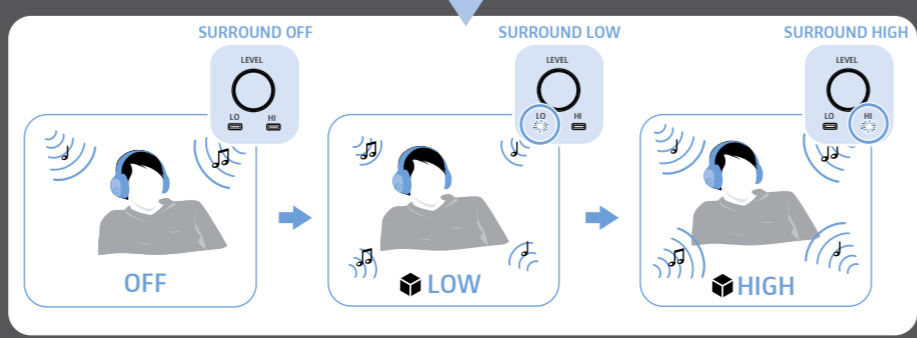
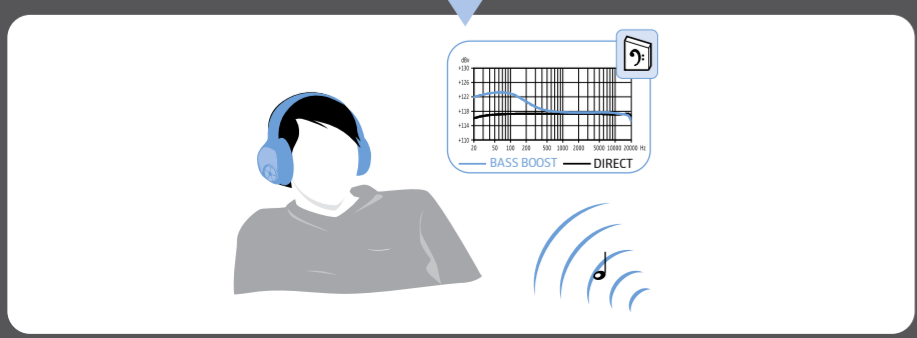
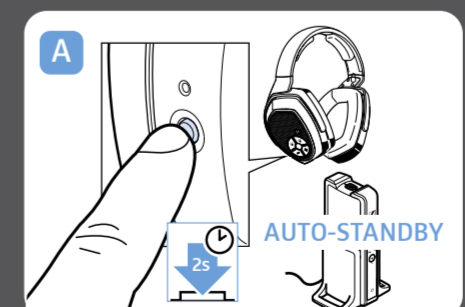
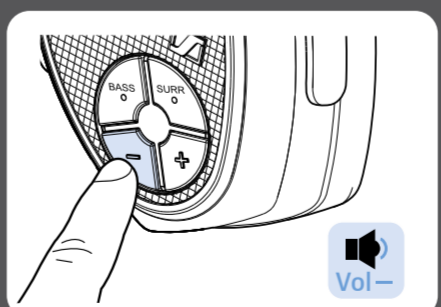
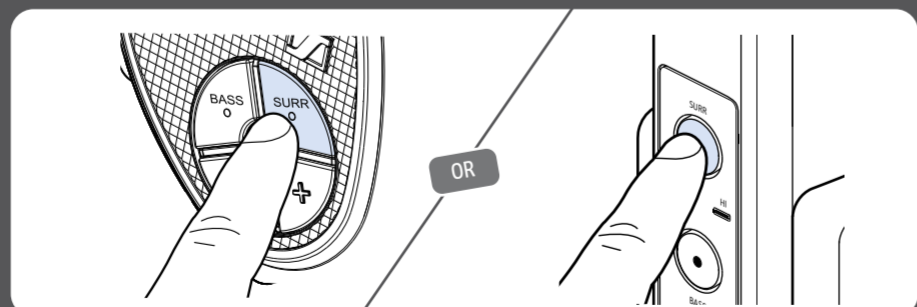
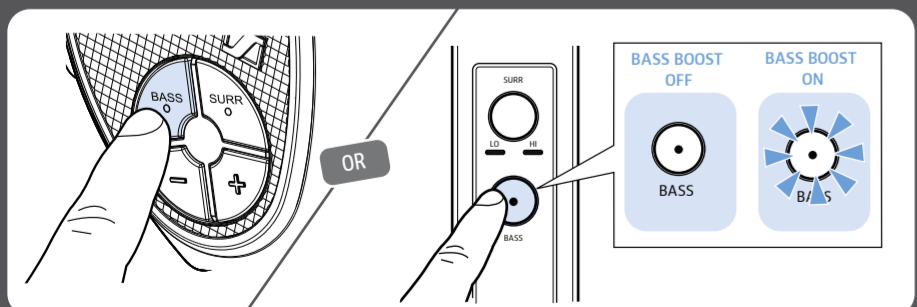

Instruction Manual Bedienungsanleitung Notice d'emploi Instrucciones de uso Manual de instruções Gebruiksaanwijzing Istruzioni per l'uso Betjeningsvejledning Bruksanvisning Käyttöohje	Οδηγίες λειτουργίας Instrukcja obsługi Kullanma kılavuzu Руководство по эксплуатации 説明書 使用说明书 使用説明書 매뉴얼 Buku Petunjuk	Kasutusjuhend Lietošanas instrukcija Naudojimo instrukcija Návod na použití Návod na obsluhu Kezelési útmutató Instrucțiuni de utilizare Ръководство за обслужване Navodila za uporabo Upute za upotrebu
--	--	---

[www.sennheiser.com](http://www.sennheiser.com)



Sennheiser electronic GmbH & Co. KG  
Am Labor 1, 30900 Wedemark, Germany, [www.sennheiser.com](http://www.sennheiser.com)

Publ. 08/17  
547970/A04

# RS 175

## Digital Wireless Headphone System



Quick Guide  
 Συνοπτικές οδηγίες  
 Krótka instrukcja obsługi  
 Hızlı Kılavuz  
 Краткая инструкция

クイックガイド  
 快速指南  
 快速指南  
 빠른 안내서  
 Panduan ringkas



Package includes | Συσκευασία παράδοσης | Należy do zakresu dostawy | Pake-  
 tin içindekiler | Комплектация | パッケージに同梱されている品目 | 套装包括  
 | 套装包括 | 포장 내용물 | Isi kemasan

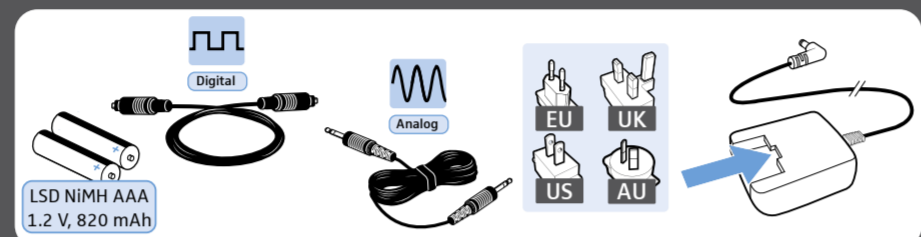
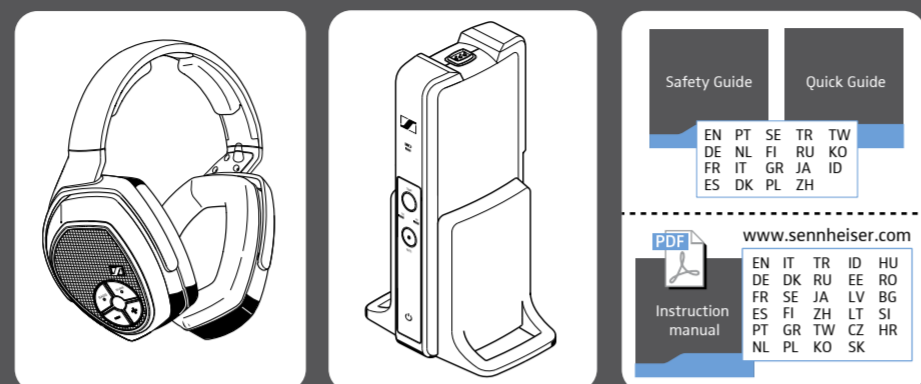

1 Connecting the transmitter to a sound source | Σύνδεση πομπού σε μια πηγή ήχου | Podłączenie nadajnika do  
 źródła audio | Vericinin bir ses kaynağına bağlanması | Присоединение передатчика к источнику аудиосигнала  
 | トランスミッターをオーディオソースに接続する | 将发射机与声源连接 | 連接發送器與音源 | 오디오 소스에  
 송신기 연결하기 | Menyambungkan transmiter ke sumber audio

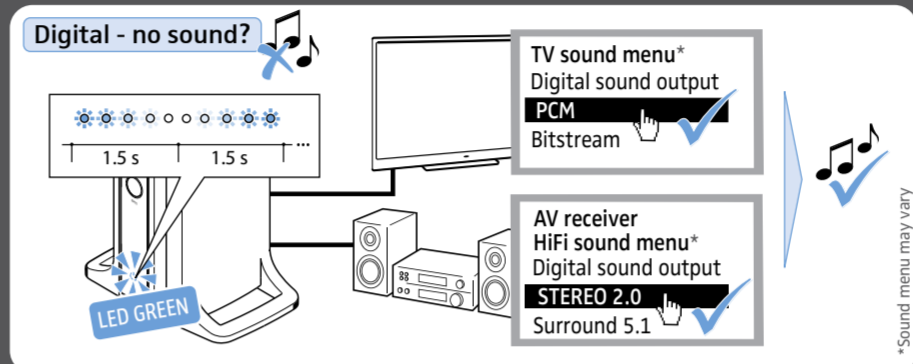
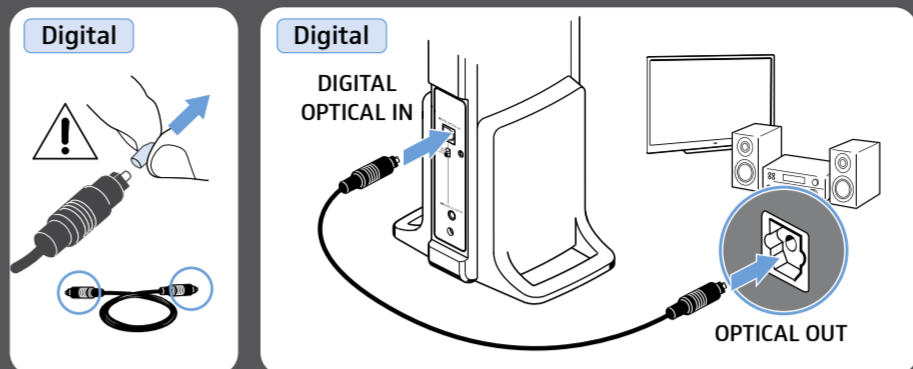

www.sennheiser.com/how-to-videos

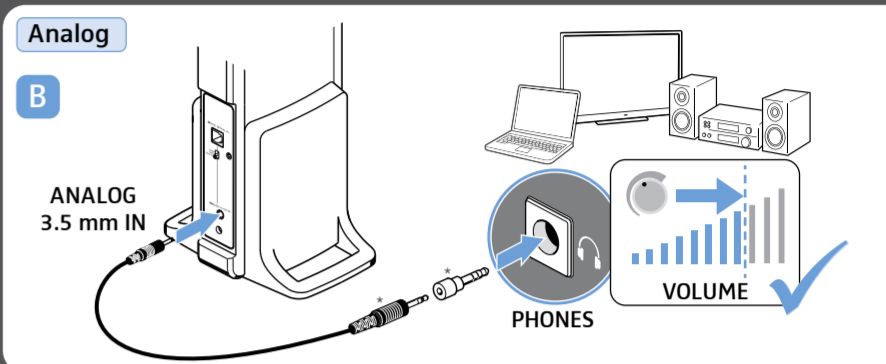
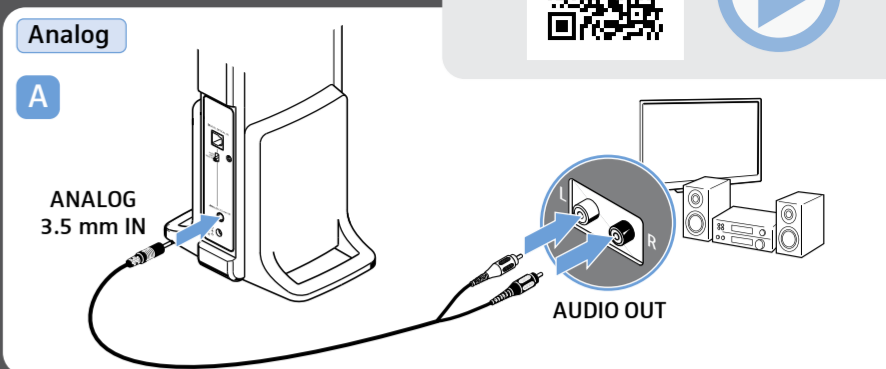

2 Connecting the transmitter to an AC wall outlet | Σύνδεση πομπού στο  
 ηλεκτρικό ρεύμα | Podłączenie nadajnika do gniazda elektrycznego |  
 Vericiji bir AC duvar prizine bağlayın | Присоединение передатчика к  
 розетке сети переменного тока | 送信機を AC コンセントに接続する | 把发  
 射器连接到一个壁装交流电插座 | 把發信器連接到牆上AC插座 | AC 벽  
 콘센트에 송신기 연결 | Menghubungkan transmiter ke outlet dinding AC

3 Inserting or replacing the rechargeable batteries | Τοποθέτηση ή  
 αντικατάσταση μπαταριών | Wkładanie lub wymiana akumulatorów |  
 Yeni den şarj edilebilir pilleri yerleştirme veya değiştirme | Установка или  
 замена аккумуляторов | 充電式電池を挿入または交換する | 插入或替换充  
 电电池 | 裝入或更換可充電電池 | 충전 배터리의 삽입 또는 교환 |  
 Memasukkan atau mengganti baterai yang dapat diisi ulang

4 Charging the rechargeable batteries | Φόρτιση μπαταριών | Ładowanie  
 akumulatorów | Akülerin şarj edilmesi | Зарядка аккумуляторов | 充電  
 式バッテリーを充電する | 給蓄電池充电 | 將充電電池充電 | 배터리  
 충전 | Mengisi daya baterai

5 Switching the RS 175 on and selecting the audio input | Ενεργοποίηση  
 του RS 175 και επιλογή εισόδου ήχου | Włączanie RS 175 i wybór wejścia  
 audio | RS 175 cihazını açın ve ses girişini seçin | Включение RS 175 и  
 выбор аудиовхода | RS 175 を ON にして音声入力を選択する | 接通 RS 175  
 并选择音频输入 | 打開 RS 175 的電源並選擇聲音輸入 | RS 175 켜기 및  
 오디오 입력 선택 | Mengaktifkan RS 175 dan memilih input radio

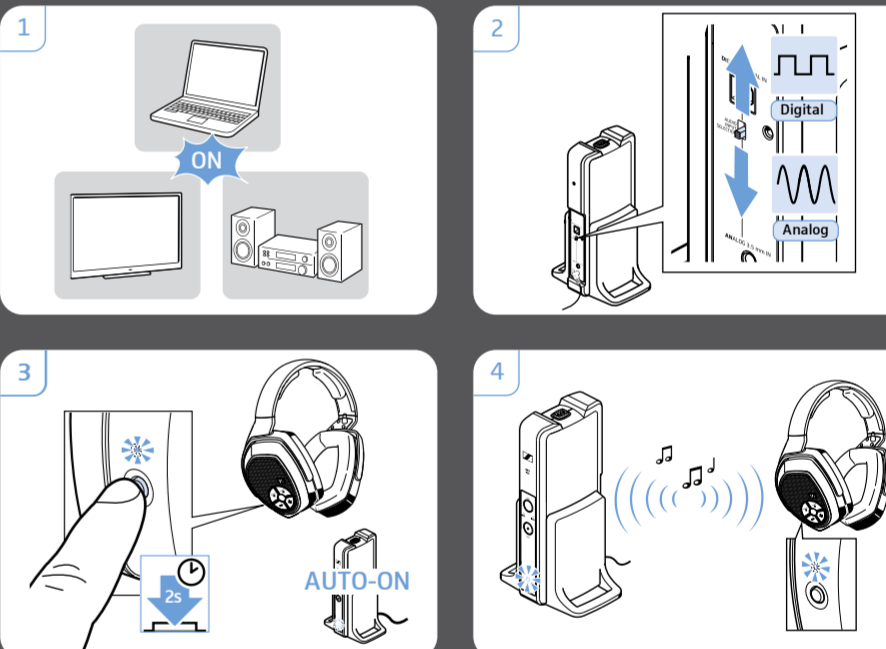
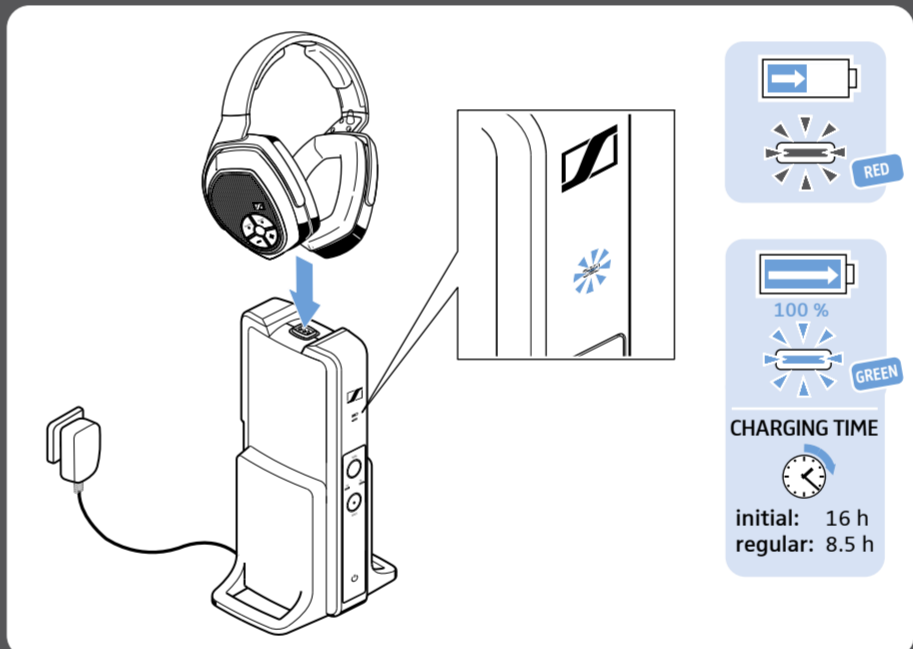
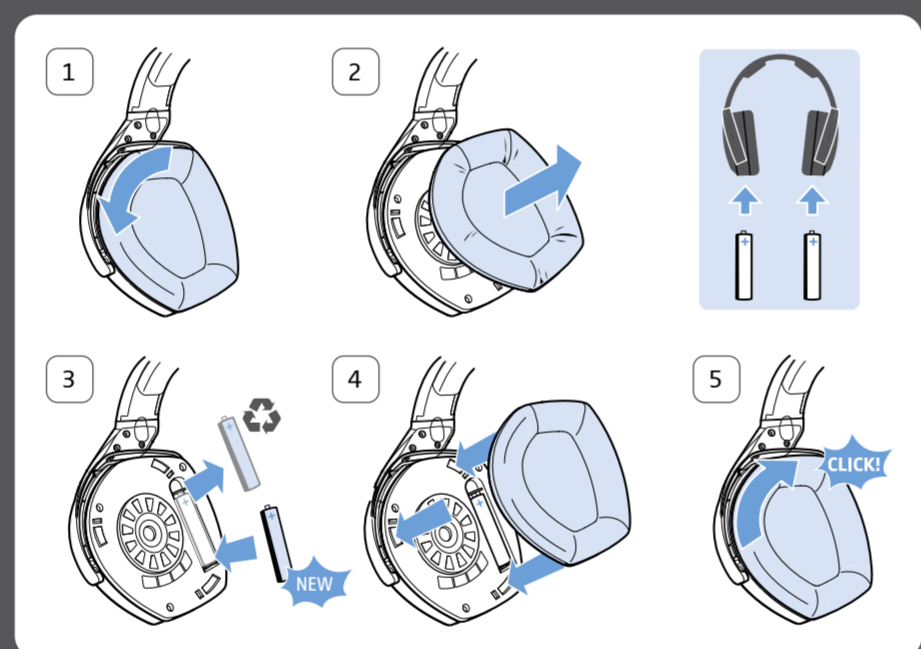
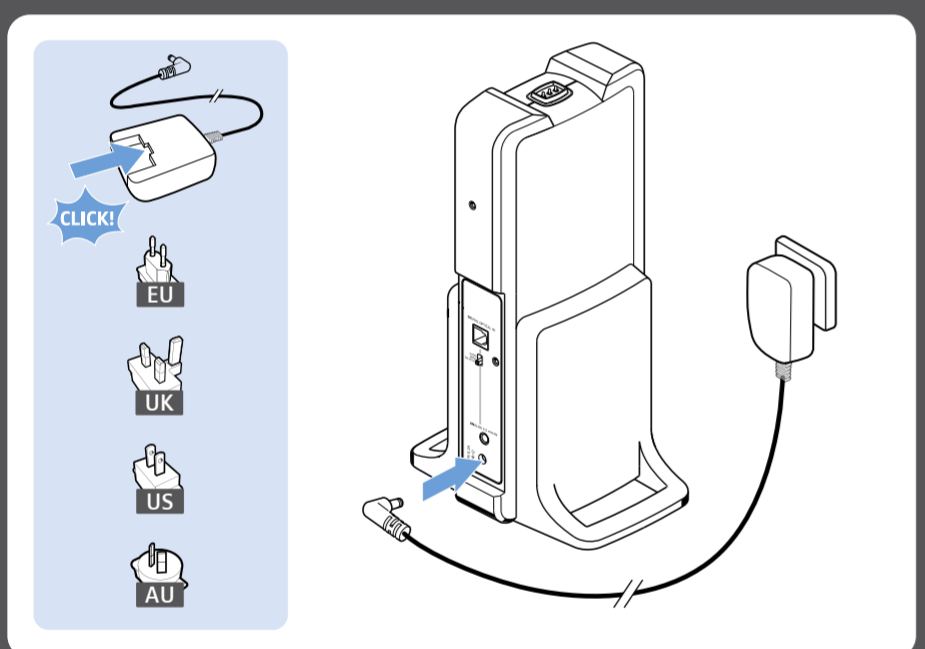

6 Activating/deactivating the dynamic bass boost | Ενεργοποίηση και  
 απενεργοποίηση δυναμικής ενίσχυσης μπάσων | Aktywacja/Dezaktywacja  
 dynamicznego wzmacnienia basów | Dinamik bas boost  
 etkinleştirme/devre dışı bırakma | Активирование/ деактивирование  
 динамического усиления низких частот | Dynamic Bass Boost を有効/無効に  
 する | 启动/关闭动态低音增强效果 | 啟用/停用動態低音強化 | 다이나믹  
 베이스 강화 활성화/비활성화 | Mengaktifkan/menonaktifkan pendorong bass  
 dinamis (dynamic bass boost)

7 Toggling between different surround sound levels | Εναλλαγή ανάμεσα σε  
 διαφορετικές λειτουργίες Surround-Sound | Przełączanie pomiędzy  
 różnymi poziomami dźwięku przestrzennego | Farklı mekansal ses  
 seviyeleri arasında geçiş yarma | Переключение между различными  
 уровнями объемного звучания | サラウンドサウンドレベルを切り替える | 在  
 不同环绕声等级之间进行切换 | 切换至不同的環迴立體聲水平 | 다른  
 서라운드 사운드 레벨 간 전환 | Mengaktifkan/menonaktifkan tingkat suara  
 surround yang berbeda

8 Adjusting the volume | Ρύθμιση έντασης | Regulacja  
 głośności | Ses şiddetinin  
 ayarlanması | Регулировка громкости  
 звука | 調整音量 | 音量を設定する |  
 调节音量 | 볼륨 조절하기 | Mengat-  
 tur volume suara

9 Switching the RS 175 off | Απενεργοποίηση του RS 175 |  
 Wyłączanie systemu RS 175 |  
 RS 175 setinin kapatılması |  
 Выключение RS 175 | RS 175 をオフ  
 にする | 关闭 RS 175 | 關閉 RS 175 |  
 RS 175 끄기 | Menonaktifkan RS 175

Detailed instruction manual and additional information | Αναλυτικές οδηγίες  
 λειτουργίας και περισσότερες πληροφορίες | Szczegółowa instrukcja obsługi  
 oraz dodatkowe informacje | Ayrıntılı kullanım kılavuzu ve ek bilgiler |  
 Подробное руководство по эксплуатации и дополнительная информация |  
 詳しい取扱説明書と追加情報 | 详细的指导手册和附加信息 | 詳細使用説  
 明書和附加資訊 | 자세한 사용 설명서 및 추가 정보 | Buku petunjuk detail  
 dan informasi tambahan

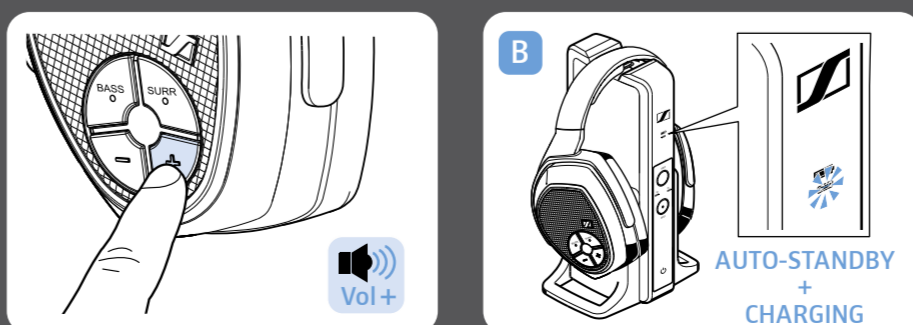
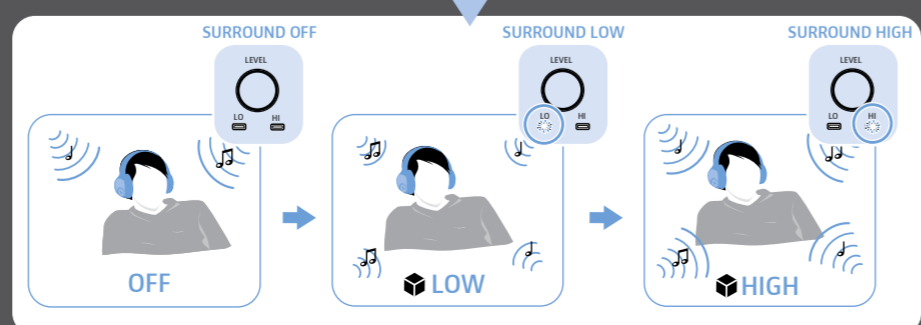
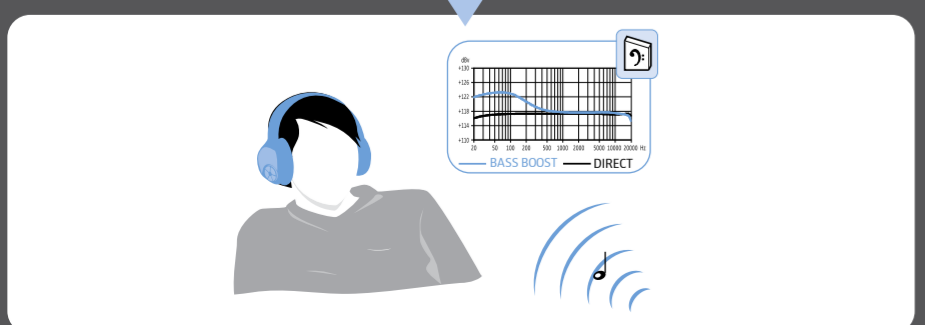
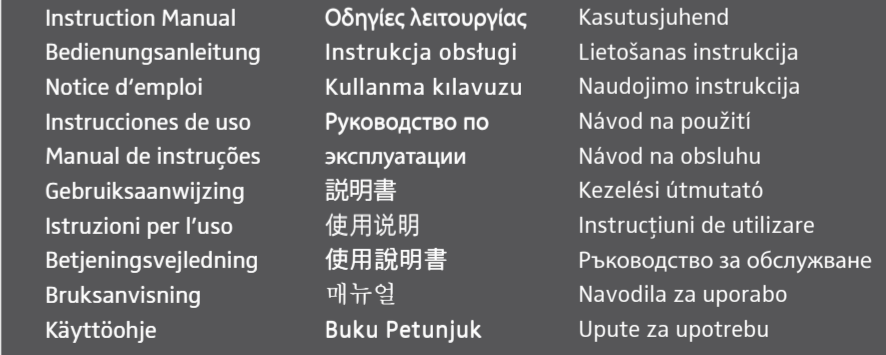
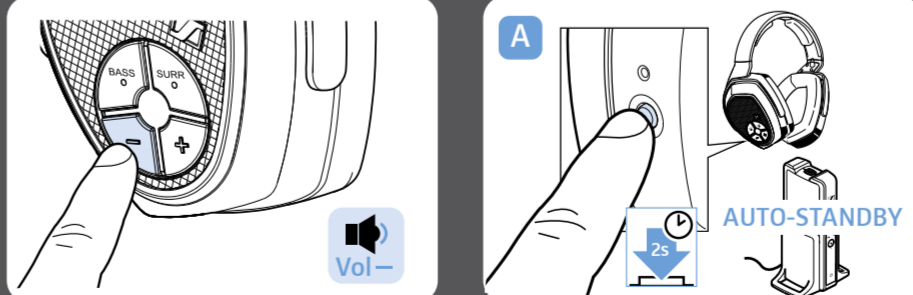
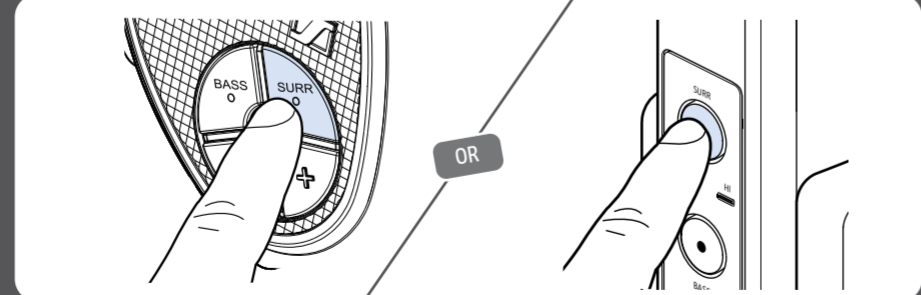
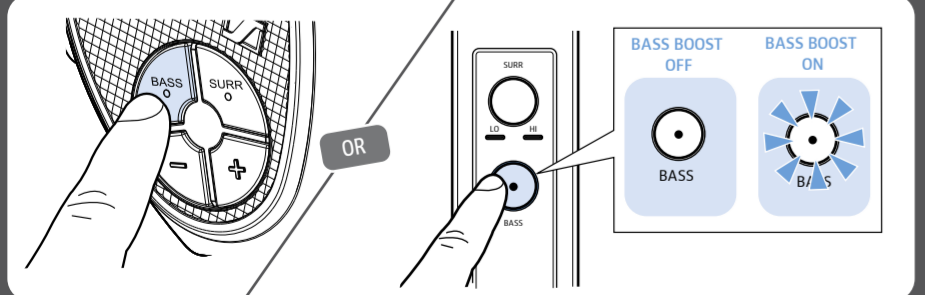

# RS 175

## Digital Wireless Headphone System



Lühijuhend  
Isä instrukcija  
Truppoji naudojimo instrukcija  
Stručný návod k použití  
Stručný návod

Rövid útmutató  
Instrucțiuni succinte  
Kratko rъководство  
Kratka navodila  
Kratke upute



Tarnekomplekt | Komplektācija | Pakete | Rozsah dodávky | Rozsah dodávky | Szállított tartozékok | Conținut pachet de livrare | Обем на доставката | Obseg dobave | Opseg isporuke

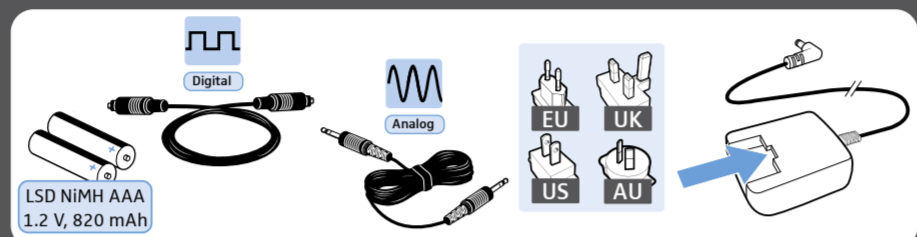
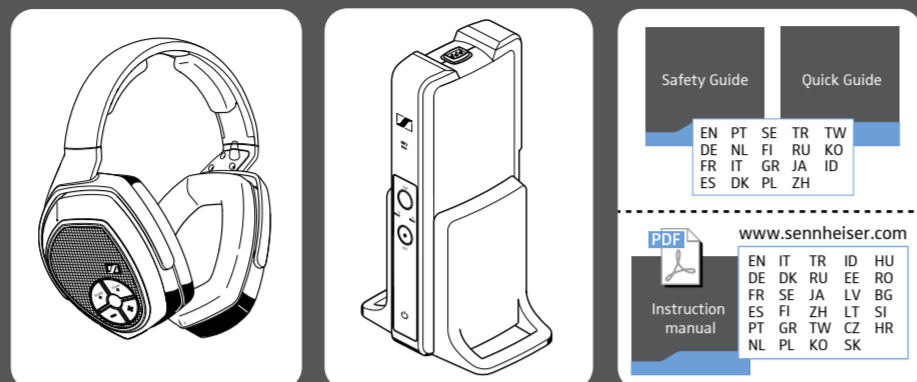

1 Saatja ühendamine audioallikaga | Raiditāja pieslēgšana pie audio avota | Siųstuva prijungti prie garso šaltinio | Připojení vysílače ke zdroji zvuku | Pripojenie vysílača k zdroju zvuku | Az adó csatlakoztatása egy hangforráshoz | Conectarea emițătorului la sursa audio | Свързване на предавателя към аудио източник | Priključitev oddajnika na vir zvoka | Odašiljač priključiti na izvor zvuka

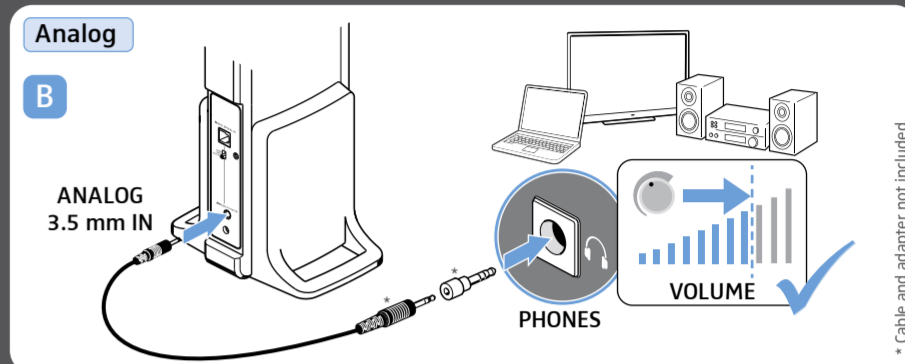
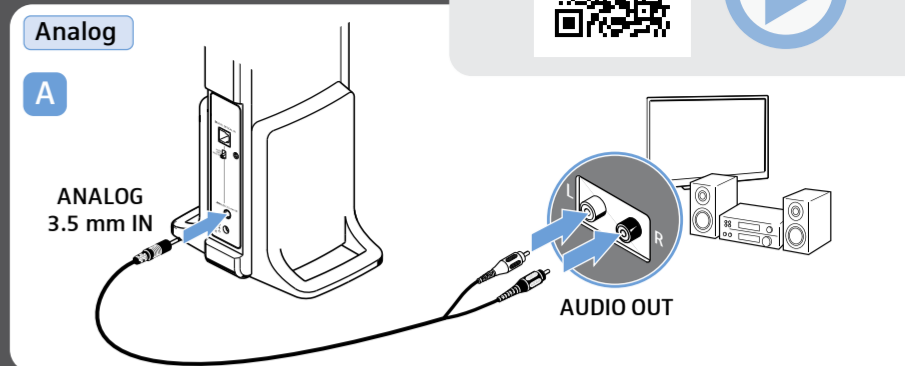
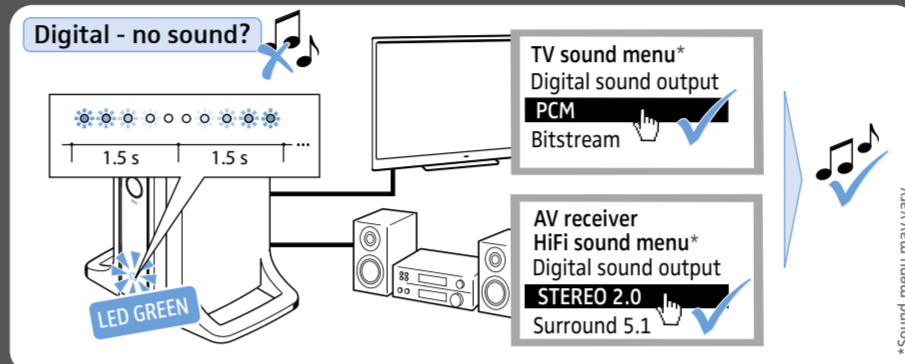
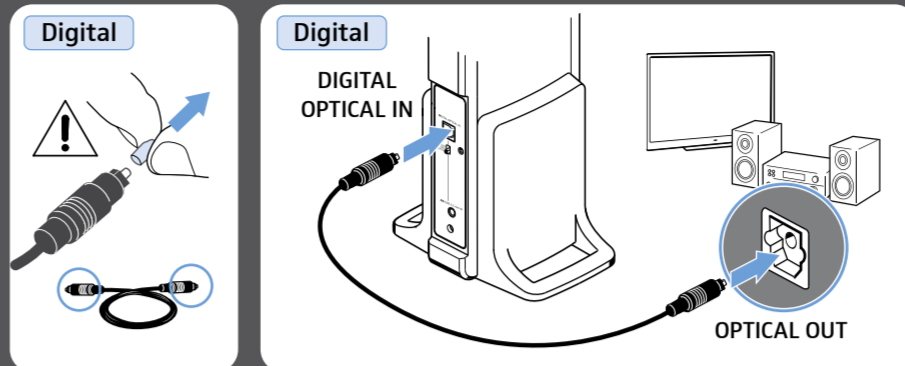

www.sennheiser.com/how-to-videos



2 Saatja ühendamine vooluvõrku | Raiditāja pieslēgšana pie elektrotīkla | Siųstuva prijungti prie elektros tinklo | Připojení vysílače k elektrické síti | Pripojenie vysílača do siete | Az adó csatlakoztatása a villamos hálózathoz | Conectarea emițătorului la rețeaua de curent electric | Свързване на предавателя към електрическата мрежа | Priključitev oddajnika na električno omrežje | Priključiti odašiljač na strujnu mrežu

3 Akude sissepanek või vahetamine | Bateriju ievietošana vai nomainīšana | Įdėti arba pakeisti baterijas | Vložení nebo výměna baterií | Vloženie alebo výmena batérií | Az akkumulátor behelyezése vagy cseréje | Introducerea și schimbarea acumulatorilor | Поставяне на батериите или смяна | Vstavljanje ali zamenjava akumulatorskih baterij | Umetnuti ili izmijeniti baterije

4 Akude laadimine | Bateriju uzlādēšana | Įkrauti baterijas | Nabijení baterií | Nabijanie batérií | Az akkumulátor töltése | Încărcarea acumulatorilor | Заряджәне на батерии | Polnjenje akumulatorskih baterij | Napuniti baterije

5 RS 175 sisselülitamine ja audiosisendi valimine | RS 175 ieslēgšana un audio ieejas izvēle | Įjungti RS 175 ir pasirinkti garso signalo įėjimą | Zapnutí sluchátek RS 175 a volba zvukového vstupu | Zapnutie RS 175 a výber audio vstupu | Az RS 175 bekapcsolása és az audiobemenet kiválasztása | Punerea în funcțiune a RS 175 și selectarea sursei audio | RS 185 включване и избор на аудио вход | Vklap sistema RS 175 in izbira vhoda zvoka | Uključiti RS 175 i odabrati audioulaz

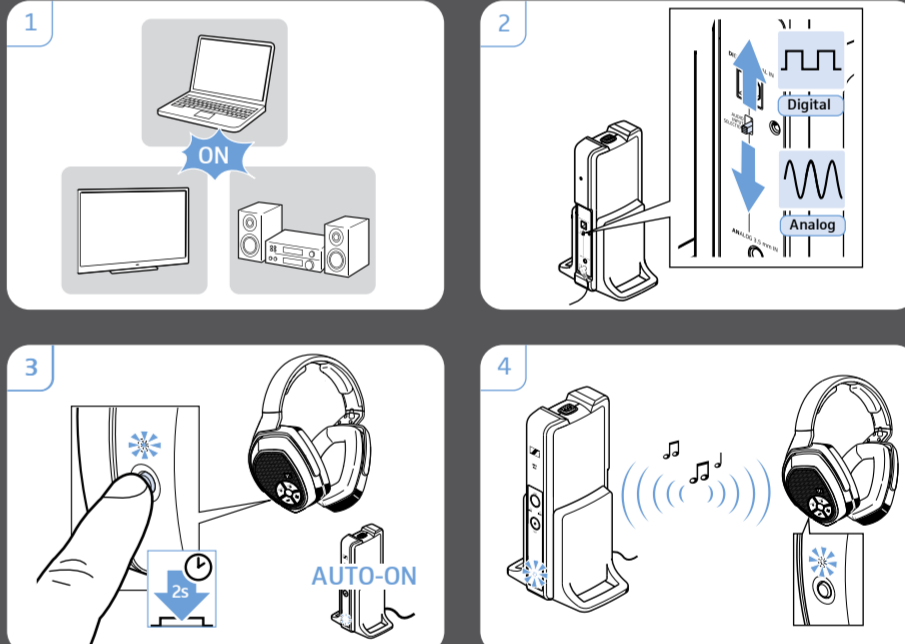
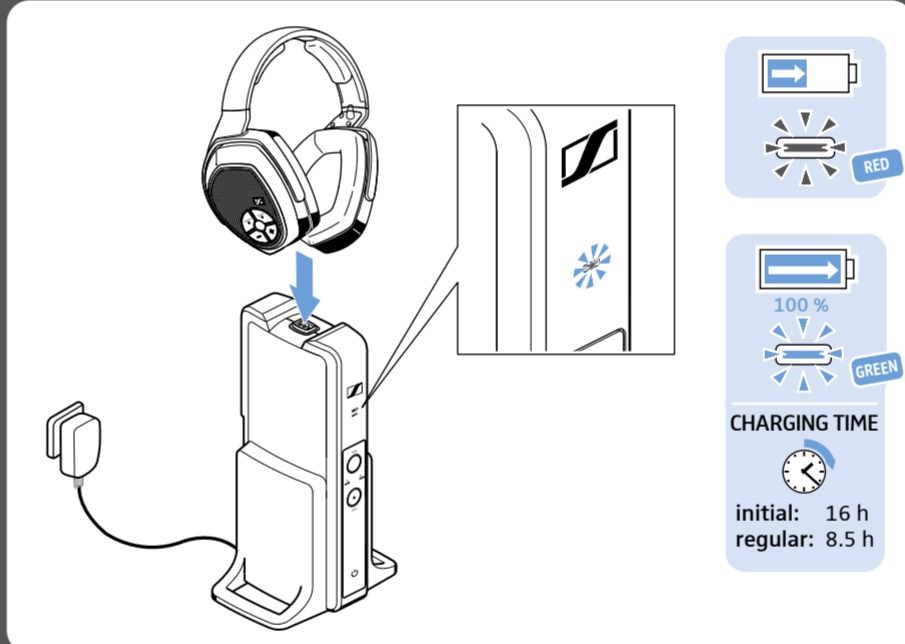
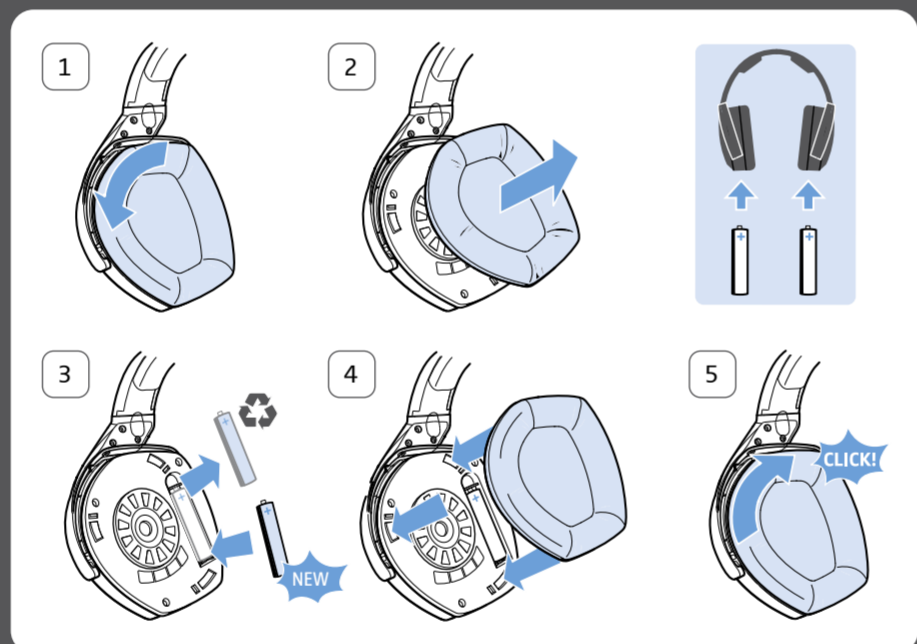
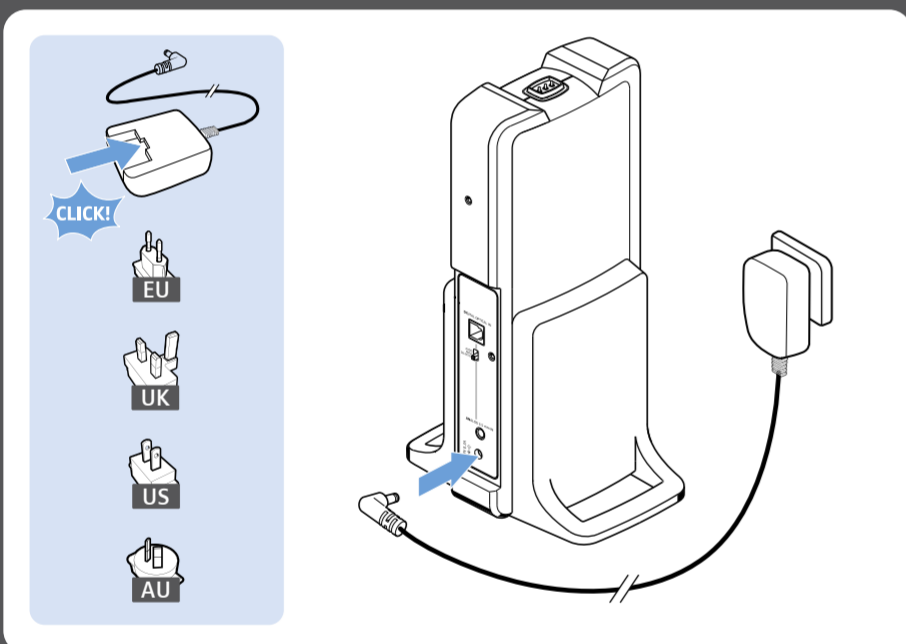

6 Dūnaamīlīse bassi suurendamise sisse- ja väljalülitamine | Dinamiskā basa pastiprinājuma ieslēgšana un izslēgšana | Įjungti ir išjungti dinaminio žemųjų dažnių stiprinimo funkciją | Zapnutí nebo vypnutí dynamického zvýraznění basů | Zapnutie a vypnutie dynamického zvýšenia basov | A dinamikus basszuserősítés be- és kikapcsolása | Pornirea și oprirea amplificării dinamice a basului | Цифрово усиливане на басите включване и изключване | Vklap in izklop dinamičnega ojačanja nizkih tonov | Uključiti i isključiti dinamičko pojačanje basova

7 Erinevate ruumikõla-režiimide vahel ümberlülitamine | Dažādu Surround-Sound (telpiskās skaņas) līmeņu pārlēgšana | Pasirinkti vieną iš skirtingų erdvinio garso režimų | Přepínání mezi různými režimy prostorového zvuku | Přepínanie medzi rôznymi režimami zvuku | Átkapcsolás a különböző surround hangmódok között | Comutarea între diferite moduri de sunet surround | Превключване между различни режими на съраунд звук | Preklop med različnimi načini prostorskega zvoka | Prebacivati između različitih načina rada prostornog ozvučenja

8 Helitugevuse seadmine | Skaluma iestāšana | Nustatyti garsumą | Nastavení hlasitosti | Nastavenie hlasitosti | A hangerő beállítása | Reglarea volumului | Настройка силата на звука | Nastavitev glasnosti | Podesiti glasnoću zvuka

Põhjalik kasutusjuhend ja muu teave | Detalizēta lietošanas instrukcija un papildu informācija | Išsami naudojimo instrukcija ir papildoma informacija | Podrobný návod k použití a další informace | Podrobný návod na obsluhu a ďalšie informácie | Részletes kezelési útmutató és további információk | Instrucțiuni de utilizare detaliate și informații suplimentare | Подробно ръководство за експлоатация и допълнителна информация | Натанчна navodila za uporabo in druge informacije | Opširne upute za upotrebu i daljnje informacije

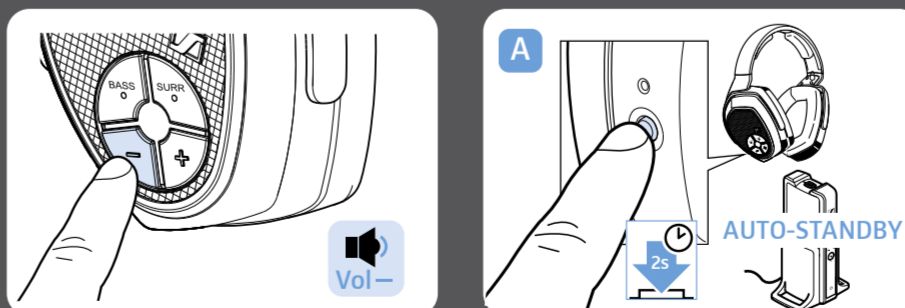
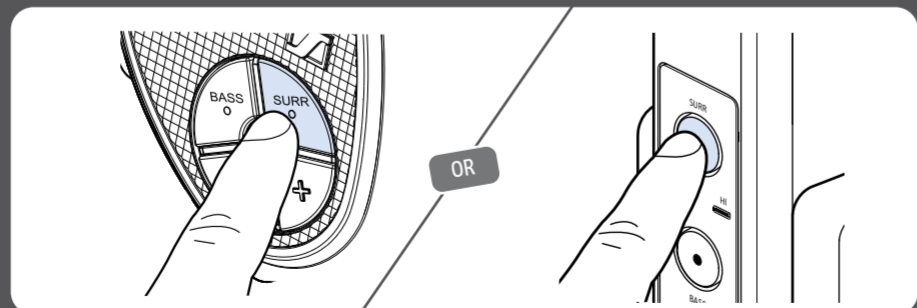
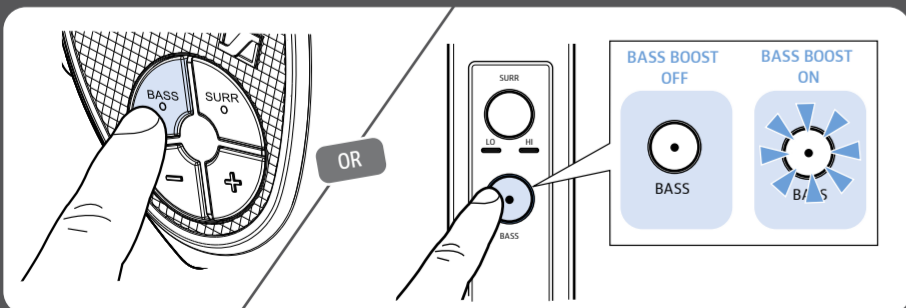

Instruction Manual  
Bedienungsanleitung  
Notice d'emploi  
Instrucciones de uso  
Manual de instruções  
Gebruiksaanwijzing  
Istruzioni per l'uso  
Betjeningsvejledning  
Bruksanvisning  
Käyttöohje

Οδηγίες λειτουργίας  
Instrukcja obsługi  
Kullanma kılavuzu  
Руководство по эксплуатации  
説明書  
使用说明书  
使用説明書  
매뉴얼  
Buku Petunjuk

Kasutusjuhend  
Lietošanas instrukcija  
Naudojimo instrukcija  
Návod na použití  
Návod na obsluhu  
Kezelési útmutató  
Instrucțiuni de utilizare  
Ръководство за обслужване  
Navodila za uporabo  
Upute za upotrebu

www.sennheiser.com

